

[Getting Started](#)

[Advanced topics](#)

TR4050 User's Manual

[Help & Reference](#)

[Programming Mode Menu Reference](#)

[Online Items \(Settings\) Reference](#)

[Onscreen message reference](#)

[ProxData on the web](#)

[Check for updates](#)

[Tell us what you think!](#)

A.1.1. What's new in this Manual

New Manual release the TR4050 (firmware V3.71G) online Time Recorders. The new model Time Recorder TR4050 has fingerprint reader module and Mifare card reader module. And also has a USB Disk port for user to download attendance data from TR4050 database. The TR4050 has an Ethernet interface (TCP/IP protocol) and can be placed directly on a Local Area Network (LAN).

With the addition of the TR4050 to the TR40xx Terminal family, the number of possible network configurations using TR4020, TR4050, or both TR4020 and TR4050 has been increased. See [Using Online communications](#) and [I/O Connector pin assignment & Cable wiring](#) for the added data.

The addition of the Ethernet interface required several new Items in the Main Menu and onscreen messages to be introduced in the TR4050. These are described in [All Main Menu Items](#) and [All Onscreen messages](#) respectively. Whenever the Main Menu Item or an Onscreen message can be found on the TR4050 only, this will be marked with a “TR4050 only” sign.

A.1.2. How to use this Manual

This Manual was created more like a reference rather than for continuous reading. While you are by no means discouraged from taking your time to study this Manual, there is little practical reason to read it all. You are recommended to complete [Getting started](#) and [Advanced topics](#). The [Reference](#) can be used on-demand, i.e. when you actually have a question or problem. We would like to draw your attention to the following resources that can be helpful in finding an answer:

- [All Main Menu Items](#) provides an in-depth information on each and every Item of the Main Menu
- [All Online Items](#) covers everything that can be setup online via the TR4050 network
- [All Onscreen messages](#) provide an explanation for every message that the TR4050 may display.

A.1.3. Seeking further assistance

If you cannot find the answer to your question or problem, you are encouraged to e-mail us. Use...

- promag@gigatms.com.tw for all your technical problems

You are also welcome to visit our website at...

- www.gigatms.com.tw to find some others solution

A.1.4. Table of Contents

B. Getting started	5
B.1. Introduction	6
B.2. Powering up for the first time	9
B.3. Working in the Normal Mode	11
B.4. Saving Time and Attendance data to the USB Disk	13
C. Advanced topics	14
C.1. Working in the Programming Mode	15
C.2. Database organization and management	20
C.3. Speeding up User registration	22
C.4. Working with external scanner	25
C.5. Fine-tuning ID-code processing	26
C.6. Using the TR4050 as an Access Control Terminal	27
C.7. Controlling external Bell (Ring)	28
C.8. Using Online communications	29
C.9. Viewing data on the PC	31
C.10. UPS battery	32
D. Reference	33
D.1. All Main Menu Items	34
D.2. All Online Items	64
D.3. All Onscreen messages	89
D.4. Performing a System Reset	126
D.5. Downloading new application firmware	127
D.6. Time and Attendance data file format	132
D.7. Bell and Lock control relays	133
D.8. I/O Connector pin assignment & Cable wiring	135
D.9. Rotating base cover for desktop operation	137
D.10. Specifications & Ordering Information	138

B. Getting started

Click on one of the links below:

[Introduction](#)

[Powering up for the first time](#)

[Working in the Normal Mode](#)

[Saving Time and Attendance data to the USB Disk](#)

B.1. Introduction

B.1.1. General Information

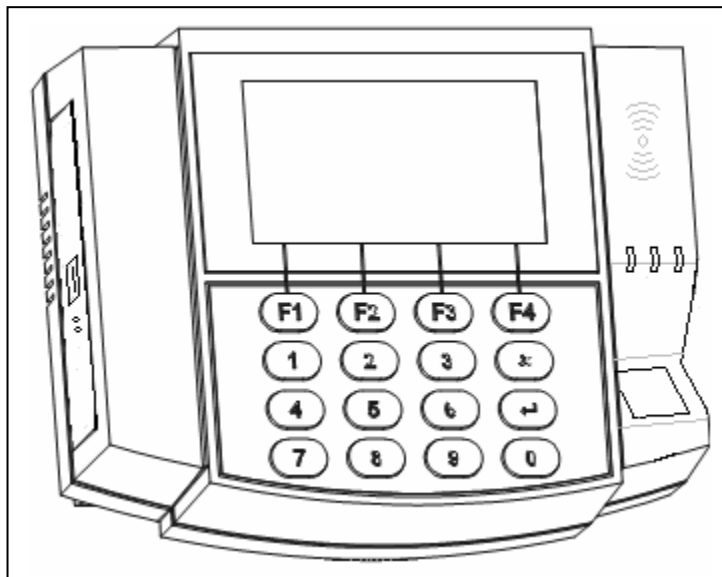

The TR4050 is Online Time Recorder with USB Disk port and fingerprint reader. The TR4050 has an Ethernet port (TCP/IP protocol) and can be placed on the Local Area Network (LAN) directly.

The TR4050 has two modes of operation: the Normal Mode and the Programming Mode.

In the Normal Mode, the Terminal is accepting User registration. Users register by selecting an appropriate Event (IN, OUT, etc.), entering Shift, then reading their fingerprint or ID-card. The Time and Attendance data is accumulated in the TR4050's internal non-volatile memory. Later, you can save the data to the USB

Disk or upload it to the PC via Ethernet port.

Programming Mode is used to manage the Time and Attendance database, and setup the TR4050 (program its functioning parameters or "Settings"). All functions in the Programming Mode are accessed via convenient onscreen Menu. Access to the Programming Mode is protected by the Master fingerprint or Master ID-card and (optionally) a Master Password.

B.1.2. Installation

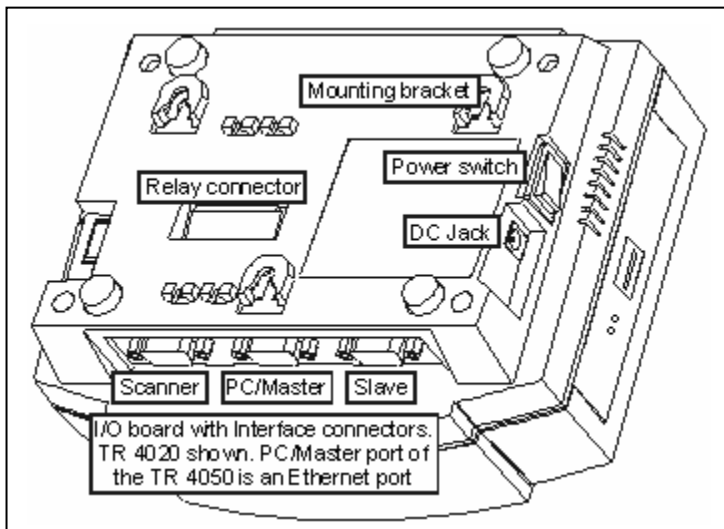

TR4050's Power switch is in "off" position (but the power is supplied from the adaptor).

For more information on the TR4050 online communications capabilities, see [Using Online communications](#) and [I/O Connector pin assignment](#).

Optionally, you can program the TR4050 to control an external Bell (Ring) and Electric Lock. For more information, see the following Sections of this Manual: [Bell and Lock control relays](#), [Controlling external Bell \(Ring\)](#), [Using the TR4050 as an Access Control Terminal](#).

The TR4050 can be used as a wall-mount or a desktop device. You can place it on the wall using the Terminal's mounting brackets (see the Figure to the left). For desktop operation, the Terminal base can be rotated 180 degrees (to adjust the front panel's viewing angle and move away I/O connectors)- see [Rotating base cover for desktop operation](#).

To operate the TR4050, you only need to plug the adaptor cable into the DC jack and turn the TR4050 on. Note, that the Terminal features a built-in [UPS battery](#). This battery is getting charged even when the

B.1.3. Where to go from here

All the basic information you'll probably need is contained in the remaining Sections of Part B. We will show you:

- [Powering up for the first time](#)- how to prepare your TR4050 for work
- [Working in the Normal Mode](#)- how to add Time/Attendance records
- [Saving Time and Attendance data to the USB Disk](#)- how to get your Time/Attendance data

After the above introduction you probably won't need any further assistance. Note, however, that there is still a lot of useful information in the [Advanced topics](#) Section. In addition, the [Reference](#) can be used to find answers to your specific questions.

B.2. Powering up for the first time

The TR4050 arrives from the factory (dealer) in a completely reset state. When you switch it on for the first time, you'll see the screen like the one shown below.

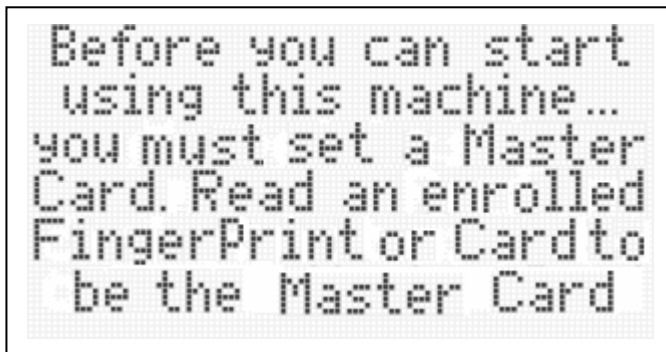

If this screen is not displayed, then the TR4050 may not be in a default condition and you need to reset it first- see [Performing a System Reset](#) for instructions.

As follows from the initial on-screen message, you are supposed to set the Master ID-card (or simply Master Card) or Master Fingerprint first. In the future, you will read the Master Card or Master Fingerprint to access the Programming Mode. Programming Mode is used to setup the Terminal's functioning parameters, etc.

The reason Master Card or Master Fingerprint exists is to protect the Terminal's data from unauthorized observation or editing. It serves as a kind of supervisor key to the Terminal's data.

The Master Card or Master Fingerprint is not some kind of a special card- you can choose any working ID-card or finger to become the Master Card or Master Fingerprint. The TR4050 comes with three ID-cards you can just select one of them. You can always change the Master Card or Master Fingerprint later.

To set the Master Card or Master Fingerprint, you should enroll fingerprints or card for TR4050 fingerprint reader first (please refer to document "[TR4050 Fingerprint Register Guide.pdf](#)" in attached disk), then simply read the card or fingerprint of your choice: bring the card to the reader proximity in case of TR4050.

To set the Master Card or Master Fingerprint, you may get a read error. The Terminal will generate a long beep and display a “Read error. Please, try again” message. Please has the card or finger to be read again- make sure that you do this correctly.

After a good read, the TR4050's screen will display the message shown below.

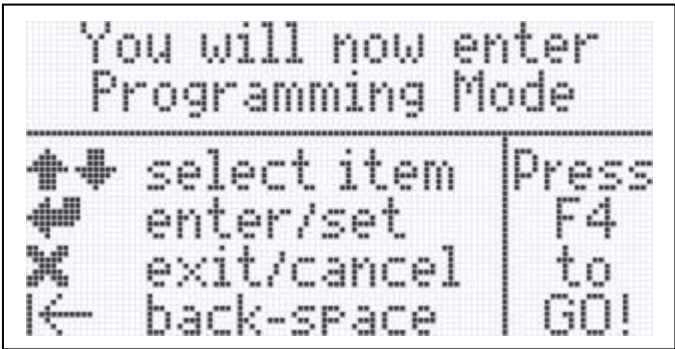

This is simply a short information screen that informs you about the F-key functions in the Programming Mode.

Press **F4** key- the TR4050 will enter the Programming Mode and you will see a Main Menu. At this point, you can either choose to take a look around the Programming Mode, or exit it right away. Complete information about the Programming Mode is provided in [Working in the Programming Mode](#)

Section.

To exit the Programming Mode:

- Press the **F1** key- the TR4050 will display the following message: “**Are you sure you want to exit Programming Mode?**”
- Press **Yes (F1)**- the TR4050 will go into the [Normal Mode](#) of operation.

B.3. Working in the Normal Mode

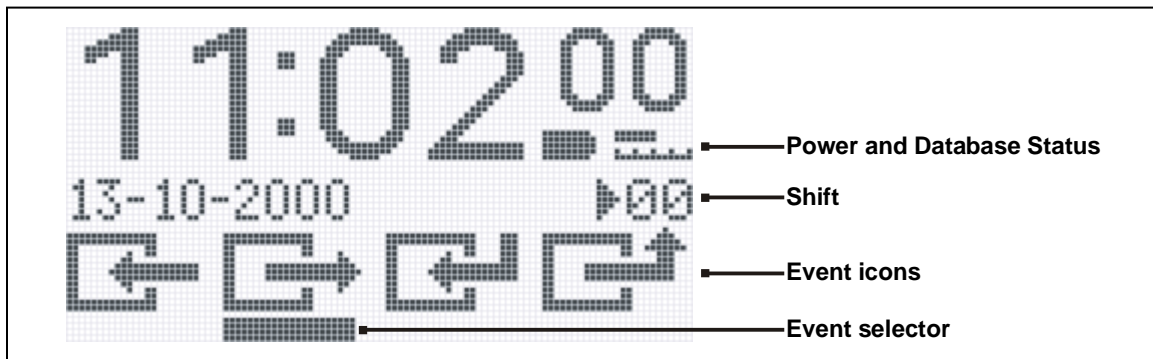

The Normal Mode of operation is where the Time and Attendance records are created. The TR4050 screen in the Normal Mode looks somewhat like the one shown above.

To create a desired record, you need to select Event and Shift first.

Event is selected using the **F1...F4** function keys. Function keys correspond to event icons displayed on the LCD screen directly above the keys. Currently selected Event is indicated by a thick bar displayed under the Event icon. Events available (left to right) are: IN, OUT, BREAK IN, BREAK OUT. Most organizations only use IN and OUT events, some separate on- and off-duty (IN and OUT) and breaks (BREAK IN and BREAK OUT) events. On the sample screenshot above, the OUT event is selected (**F2**).

The shift can be from 00 to 99 and is entered using the **0...9** numerical keys.

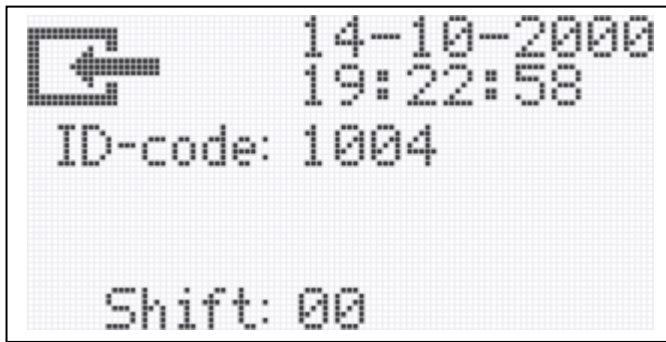

After you make sure that selected Event and Shift are correct, read the fingerprint or User ID-card (fingerprint or user Card is any working ID-card other than the Master Fingerprint or Master Card). A confirmation screen is displayed every time a new record is created. The screen shows the registered event, time and date, ID-code of the fingerprint or User Card, and the Shift (see the screenshot to the left).

A new User Record is created every time you read the fingerprint or User Card. Remember, that the data for the record (Event and Shift) must be set before reading the fingerprint or User Card. There are ways to speed up the User registration by automating the Event and Shift Selection- see [Speeding up User registration](#) for details.

The LCD screen in the Normal Mode also displays a Power and a Database status. The Battery icon, when displayed, indicates that the TR4050 is running on battery power. See [UPS battery](#) for more details. The Database Icon displays the database memory utilization in 25%-increments. On the sample screenshot above, the Database Status icon indicates that the database is at least 50% full. Complete coverage of database management and database-related issues is provided in [Database organization and management](#).

B.4. Saving Time and Attendance data to the USB Disk

The TR4050's USB Disk port supports USB Mass Storage Device only (some USB disk embedded USB Hub, TR4050 does not support this type USB Disk), and supports FAT12, FAT16, and FAT32 file system. To save the Time and Attendance data to the USB Disk you just simply insert USB Disk to USB Disk port, and then TR4050 will start saving the 'new' data to the USB Disk.

New data is the data that has never been saved to USB disk or uploaded to the PC in the past. If you want to save entire database contents, then you need to use the [Mark all as 'new'](#) command first.

TR4050 will offer you a default save filename which will be in the following format: "ddmmyyyy.txt", *dd*, *mm* and *yyyy* are the current date, month and year. This file will be saved into the directory path: \TR4000\ in USB Disk. If the filename (current date) already exist in directory \TR4000\, then data will be appended to this file. Append function allows you to save the data from multiple TR4050s into a single data file.

The green LED will blink while the TR4050 is saving the data. The operation may take a few seconds depending on the amount of data to be saved. Any error occurs when save data to USB Disk the red LED will blink 10 times, or blink 15 times when USB Disk enumeration error.

To protect data for unauthorized downloading by anyone, you should set the Login password first (see [Login Password](#)), then save this password to the specified filename "TR40x0.txt" (you can use the Windows accessory software- "Note" to edit "TR40x0.txt") and put this file into directory \TR4000\, for advanced protection data you better to set the attribute to "hidden" for file "TR40x0.txt". You can use the [Sample software](#) to set Login password for TR4050.

When the data saving is finished, these data will be marked as 'old' and will be preserved in the Terminal's database memory. By default, it will not be saved to USB disk or uploaded to the PC unless you specifically request to do so. Please, See the [Database organization and management](#) for complete information on the database-related issues.

C. Advanced topics

Click on one of the links below:

[Working in the Programming Mode](#)

[Database organization and management](#)

[Speeding up User registration](#)

[Working with external scanner](#)

[Fine-tuning ID-code processing](#)

[Using the TR4050 as an Access Control Terminal](#)

[Controlling external Bell \(Ring\)](#)

[Using Online communications](#)

[Viewing data on the PC](#)

[UPS battery](#)

C.1. Working in the Programming Mode

Programming Mode of operation is used to manage the Time and Attendance database, and setup the TR4050's functioning parameters (Settings).

C.1.1. Entering Programming Mode

For security reasons, access to the Programming Mode is protected by a [Master ID-card](#) or [Master Fingerprint](#) and (optionally) a [Master password](#) (disabled by default). You have already set the [Master card](#) or [Master Fingerprint](#) when you've [powered the TR4050 up for the first time](#).

To enter the Programming Mode:

- Read current [Master Card](#) or [Master Fingerprint](#). If the Card or Fingerprint you read is not a [Master Card](#) or [Master Fingerprint](#), then the TR4050 will simply register an event, i.e. process this card or fingerprint as a regular User ID-card. If this is a [Master Card](#) or [Master Fingerprint](#), then the TR4050 will either...
 - Enter Programming Mode immediately- you will see the Main Menu (like the one shown in [Navigating in Programming Mode](#))
 - Ask you to input the [Master password](#) in case the password is set. Input correct password and press **⬅(F4)**- the Terminal will enter the Programming Mode

If you loose your [Master Card](#) or [Master Fingerprint](#) or forget your [Master password](#) then you won't be able to enter the Programming Mode. The only solution in this situation is to perform a [System Reset](#)

C.1.2. Navigating in Programming Mode

The first thing you see when just having entered the Programming Mode is the Main Menu (see Figure below).

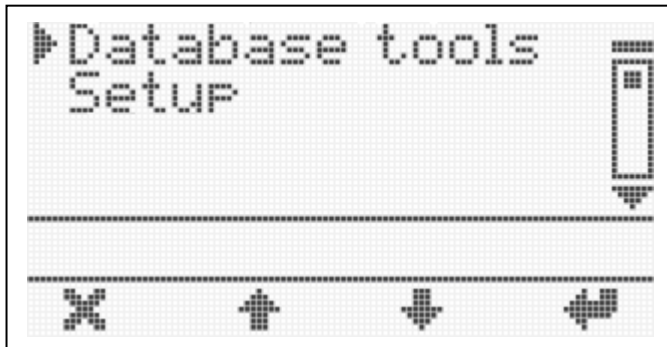

All of the TR4050 Programming Mode Items are accessible via the Main Menu. This Section is not aiming at providing a detailed description of all Main Menu Items. Instead, it will explain how to navigate in the Programming Mode in general. Complete information about all available Main Menu Items is provided in [All Main Menu Items](#).

Their functions: “Database tools” aggregates all database management stuff, while the “Setup” (containing several levels within itself too) houses all the functioning parameters (Settings). Complete Main Menu map is provided in [All Main Menu Items](#).

The Main Menu is multi-level. Menu Items are grouped together according to

Depending on the TR40xx modification and the firmware it is running, not all of the Main Menu Items mentioned in this Manual may be available. For example, you won't see the “Disk tools” because the TR4050 doesn't have a Floppy Disk Drive.

You move around the Programming Mode using the **F1...F4** keys, also **Enter** and **Cancel** keys. The current function of the F-key is always displayed on the TR4050's LCD, right above the key. For the sample screenshot above, the **F2** and **F3** keys can be used to scroll up (↑) and down (↓) along the Menu, **F1** key is used to exit to the higher menu level (✕) or cancel something, and the **F4**- to enter (select) the Menu Item (→). For example, if you want to select the “Setup”, press ↓ until the arrow at the left appears at the “Setup” line, then press → to enter. To exit back to the top menu level, press ✕.

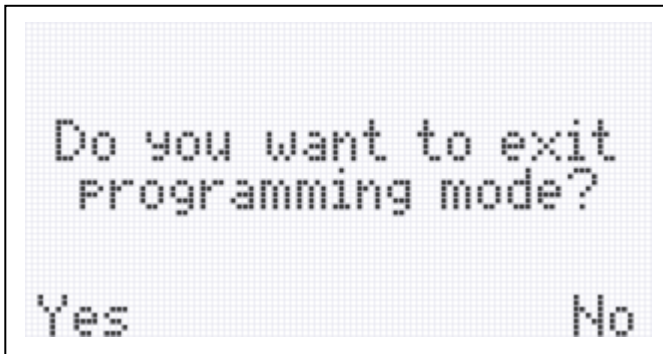

Pressing **X** when you are already at the top level of the Main Menu will prompt the TR4050 to ask you: “**Do you want to exit the Programming Mode?**” (see the Figure to the left). Notice that there are two choices displayed above the F-keys: “Yes” above the **F1** key and “No” above the **F4** key. Answer the question by pressing a desired F-key. The TR4050 displays many other messages and errors that you respond to by pressing one of the F-keys corresponding to the desired

choice on the LCD screen.

Whenever you have the screen that presents choices like Yes/Enter/Select/Set and No/Escape/Cancel, you can also use the **Enter** and **Cancel** keys on the TR4050’s keypad. For example, you can answer the question on the sample screenshot above by pressing **Enter** instead of **F1** or **Cancel** instead of **F4**. When navigating in the Main Menu, you can use the **Enter** key to select an Item or enter the lower Menu level and the **Cancel** key to exit (to the higher menu level).

C.1.3. Editing Settings

Settings are TR4050 functioning parameters. All Settings are found in the Setup folder of the Main Menu. To open this folder, use the **↓** and **↑** keys to select the “Setup” item (arrow at the left of the screen must point at it), then press **↵**.

The “Setup” folder consists of a large number of Settings. Some of these Settings are simple values, and some are data tables. Data table editing techniques are explained in [Editing Bell and Default Event tables](#). “Setup” folder also contains an “Advanced” sub-folder that aggregates all the “more sensitive” Settings. Edit it only if you really know what you are doing.

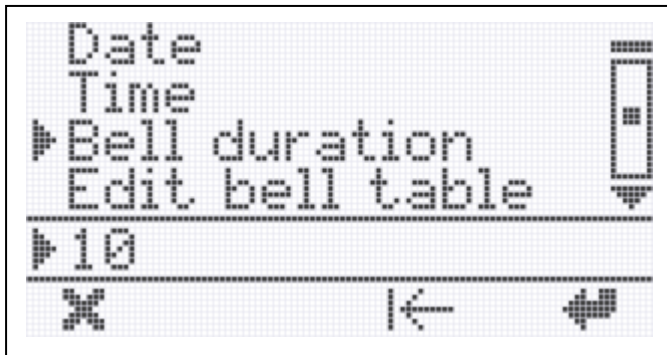

F-keys will have different meaning while you edit the Setting.

To change the Item's value, use the numerical keypad of the TR4050 for input, |← (F3) as a Backspace, and X/↵ keys as Cancel and Set (**Cancel** and **Enter** keys will also work).

C.1.4. Editing Bell and Default Event tables

“Setup” folder of the Main Menu also contains two data tables- the [Bell table](#) and the [Default Event](#) table. This Section only explains how to work with data tables, not what they mean. The latter is explained in [Using Default Event Table](#) and [Controlling external Bell \(Ring\)](#).

Both data tables of the TR4050 can contain up to 32 records (entries). You can add, edit and delete the records. By default the tables are empty.

The explanation below deals with the [Default Event](#) table, open it by scrolling to the “Edit def. event tab.” In the “Setup” folder of the Main Menu and press ↵. If the table is empty, it only shows the Add Record prompt.

Once again, this Section explains how to use the Programming Menu, not the meaning of individual Settings. See [All Main Menu Items](#) if you have a question about a particular Setting.

To edit a Setting, you must first select it. Supposing you want to set the [Bell duration](#). First, scroll to the “Bell duration” line in the Main Menu, then press ↵.

Notice that the function bar at the bottom of the LCD screen will change- the

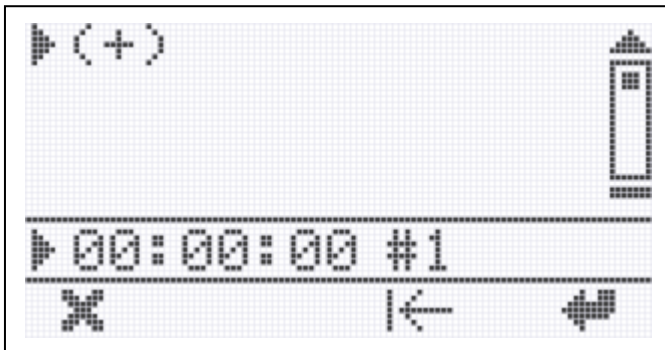

will be added and displayed on the screen.

To edit an existing record, scroll to this record using the **↑/↓** keys and press **↵** to select this record for editing.

To delete the record, select this record for editing first. Notice that the **Del** choice is available on the function bar for existing records- press **F2** to delete the selected record.

The empty table has no data records, only the “add” record prompt- (+). To add a new record, make sure that the arrow at the left of the screen points at (+) and press **↵**. The function bar will display new functions of F-keys and the edit line will display the default data for the new record (see the Figure below).

Edit new record data in exactly the same way you edit Settings (see [Editing Settings](#)) and press **↵**. The new record

C.2. Database organization and management

The TR4050 keeps the Time and Attendance data in its internal non-volatile database. Understanding internal database organization and logic is crucial to the effective Terminal management.

C.2.1. “New” and “old” data

The TR4050 distinguishes between the “new” and “old” data. New data is the data that was added to the Time and Attendance database after the last time the database contents has been saved to USB disk or uploaded to the PC via online connection. Old data is the data that has been saved to the USB disk or uploaded to the PC at least once in the past. By default, the old data is never saved or uploaded twice- it is just kept in the Terminal's memory for backup purposes (just in case you will need it again). If you want to receive the old data again, use the [Mark all as 'new'](#) command first- this will make all the data appear as if it was never saved or uploaded before.

C.2.2. Database management commands

All database management commands are grouped into the “Database tools” folder of the Main Menu.

These are: [Status report](#), [Delete saved data](#), [Mark all as 'new'](#), [Delete all data](#), [Recover data](#).

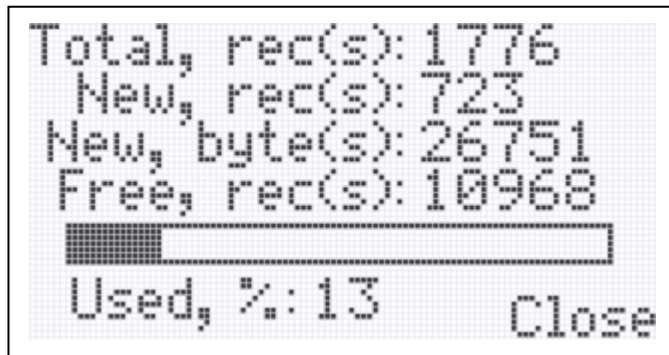

database memory utilization.

C.2.3. Checking the database status

There are two ways to check the database status. Firstly, there is a [Status report](#) command that provides a detailed status information. In addition, a Database icon displayed in the [Normal Mode](#) provides a rough estimation of the

The Database icon provides a rough measure of the number of records in the database (in 25% increments). Icon on Figure below depicts the situation when more then 50% of total database capacity is already used up. Note, that this includes both “old” and “new” records. The old records may not be visible during the save or upload operation, but they are still there and they do occupy a database space.



C.2.4. Clearing up the database space

When your database becomes full, the TR4050 won't be able to accept new data unless you reclaim some database space. Normally, you do this by deleting the old data. You do this by executing the [Delete saved data](#) command. Another way is to clear entire database by using the [Delete all data](#) command. Use the latter command with some caution- you will permanently

delete all the data, and this includes the data that was probably never saved before.

C.2.5. Repairing the database

In the unlikely event of the database malfunction, you can repair the database either by initializing it using the [Delete all data](#) command, or you can recover the database using the [Recover data](#) command.

After the recovery, the database appears to be 100% full with new records. Therefore, saving the data to the USB disk or uploading the data to the PC after the data recovery will get you entire database memory contents. Naturally, not all the data may be valid. The database memory may contain garbage records, some newer records may have overlapped the older ones, etc. Nevertheless, the data recovery is your last hope to retrieve the data you are looking for. Data recovery is also effective in case you initialize the database by accident.

C.3. Speeding up User registration

A typical organization normally has fixed working hours with increased inflows and outflows of employees at certain daytimes. Using a Time Recorder may create “registration jams” at peak periods, when there is a large number of people to clock in or out. Decreasing a per user registration time as much as possible may significantly alleviate the problem. In the TR4050, this is done through [Default Event](#) and [Default Shift](#) functions.

C.3.1. Using Default Event Table

Note: this Section provides the information on the usage of the [Default Event](#) table. Table editing techniques (i.e. how to add, edit and delete records are described in [Editing Bell and Default Event tables](#)).

User registration process consists of pressing desired Event key (IN, OUT, etc.) and reading the User ID-card or fingerprint. Event entry can be automated through the [Default Event](#) table. The table allows you to divide the day into the *timezones* and define a default event for each timezone. Within a given timezone, the TR4050 will automatically keep the default event key pre-selected so the majority of Users will not have to push any key while registering. For example, you may program the TR4050 to pre-select the IN key between the hours of 8a.m. and 10a.m when most employees are starting to work. Employees will only have to read their ID-cards or fingerprint to register- there will be no need to push the IN key each time. Practice shows that the per-user registration time can be significantly reduced this way (up to 60%).

Note: even with the [Default Event](#) function enabled, it is still possible to register an alternative event. “Irregular” User will need to press a desired Event key and read his/her ID-card or fingerprint within 10 seconds. The TR4050 will register an event and return the Event selection to the default one after the User ID-card or fingerprint is read or after a 10-second timeout. Next “regular” User will not have to select the default event manually.

[Default Event](#) table can contain up to 32 entries. Each entry is comprised of two fields: a beginning time of the timezone (“Time”) and a default event for this timezone (“Event”).

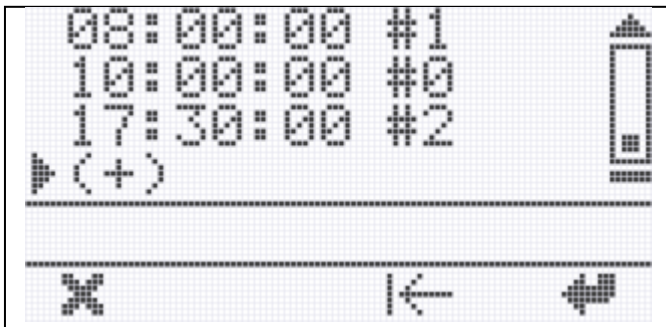

Each timezone lasts from the time specified in the Time field of one entry and up to the time specified in the Time field of the next entry (all entries are arranged in the ascending order of Time field values). The following example illustrates this.

Supposing that you have three entries as shown on the Figure to the left. This means that there are three timezones: the first one is from 8:00:00 to 10:00:00, the

second one is from 10:00:00 to 17:30:00, and the third one is from 17:30:00 and up to 8:00:00 of the next day (timezones do “wrap around”).

One interesting side effect of wrapping around is that if you only have one entry in the [Default Event](#) table (for example, 13:15:00) then this entry will be in effect around the clock, because it will work from 13:15:00 of one day to 13:15:00 of the next day, and so on. Therefore, it doesn't matter what time you will specify for a single entry in the [Default Event](#) table- it still will work around the clock. Setting it to 13:15:00 will be no different from setting it to 18:00:00. This can be use to make the TR4050 always return the selection to the desired event.

Event field value corresponds to the function key number on the TR4050's keypad that is used to select this event. For the above example, the IN (**F1**) event will be pre-selected between 8:00:00 and 10:00:00 and the OUT (**F2**) event will be pre-selected between 17:30:00 and 08:00:00 of the next day.

Setting the value of the Event field to 0 disables default event pre-selection for a specified timezone. Therefore, the TR4050 will not be selecting any event automatically between 10:00:00 and 17:30:00. The Terminal will simply keep the last event selected by the User during this time.

C.3.2. Using Default Shift

There is also a [Default shift](#) function that allows you to define a default shift that will be automatically restored after every ID-card or fingerprint read or several seconds of inactivity. [Default shift](#) is not a table- it can only be defined for the entire day. Setting the default shift to 00 disables the function.

C.4. Working with external scanner

The TR4050 allows you to attach an external scanner (reader). The data from the scanner is processed in much the same way as the data from internal reader. This way you can use two different readers at once. This can be useful if your organization circulates two kinds of ID-cards or is in the transition from one card technology to another.

For example, you can attach an external magnetic card reader to the TR4050 with built-in RFID (Mifare) reader and (temporary) accept both types of cards.

+5V power is provided on pin #9 of the Scanner Port (see [I/O Connector pin assignment & Cable wiring](#)). Maximum power that the TR4050 can supply is 100mA.

The TR4050 has several Settings to fine-tune the external reader data processing. You can set the [Baudrate](#). The data from external reader is encapsulated. You can set the [Start character](#) and the [End character](#) of each data packet from the external scanner. For example, if the data from external scanner always begins from 02 Hex and ends with 0D Hex, then you must set the [Start character](#) and [End character](#) accordingly.

Also, there are [From character](#), [Number of characters](#) and [Prefix to match](#) Settings that can be used to adjust the way the ID-code from the reader is handled. See [Fine-tuning ID-code processing](#) for more details.

C.5. Fine-tuning ID-code processing

The TR4050 has several Settings that can be used to adjust the way ID-codes from the internal reader and [external scanner](#) are processed. These are: [Prefix to match](#), [From character](#), [Number of characters](#) (there are two sets of Settings- one for the internal reader, another one- for the external scanner). In addition, there are several Settings to adjust the data processing from the external scanner- see [Working with external scanner](#) for more details.

[From character](#) and [Number of characters](#) Settings allow you to extract and store into the database a portion of every ID-code. You can also limit the range of ID-codes accepted by the system by specifying a [Prefix to match](#). This Setting defines what combination of digits must be found at the beginning of every valid ID-card.

Together, these three Settings allow you to:

- Adjust the ID-code format for the Time and Attendance database. This way you can normally tune the Terminal's output to fit the requirements of some existing PC software you want to use (some software packages expect a certain amount of digits in the ID-code, etc.)
- Implement a simple Access Control functionality- see [Using the TR4050 as an Access Control Terminal](#) for more information.

C.6. Using the TR4050 as an Access Control Terminal

We receive a lot of questions regarding whether or not the TR4050 can be used as an Access Control Terminal. Some Users take the fact that the TR4050 has an electric lock control relay (see [Bell and Lock control relays](#)) as an indication of the Terminal's ability to perform an Access Control Function. This Section will attempt to clarify this point.

The TR4050 is not an Access Control Terminal. It doesn't have an internal User database and, by default, accepts and activates the door lock on any ID-card read. The Lock relay was originally built into the Terminal for a different reason: some of our customers wanted to use the Time Recorder in conjunction with a turnstiles. This is normally done to enforce the "clocking" i.e. make sure that the person won't be able to access or exit the facility without registering first.

Later, we have extended the TR4050 firmware to provide a limited Access Control functionality. This was done by implementing a new [Prefix to match](#) Setting. When the prefix is set, the TR4050 will only accept (add the record and activate the lock) the User ID-cards (or fingerprint) with an ID-code that starts from a matching sequence of digits.

Basically, this allows you to choose a single prefix combination for your facility (organization) and issue ID-cards that have a common part (prefix), and a User ID. For example, you might choose the prefix to be "1234" and issue sequential User IDs like "001", "002", etc. Then you will have ID-cards with codes like "1234001", "1234002", etc. If you pre-program the TR4050's [Prefix to match](#) to "1234", then the Terminal will only accept the cards with the ID-codes starting from "1234". All other cards will be rejected- and that means that access won't be granted too.

Further, you can hide the prefix from appearing in the Time and Attendance database by Using the [From character](#) and [Number of characters](#) Settings. This way you can keep the prefix confidential.

This Access Control implementation is very simple, of course, and is only fit for low-security applications. Plus, you cannot control User access rights individually. On the positive side, you don't have to maintain the User database- all you need to do is issue the Cards with the correct prefix.

C.7. Controlling external Bell (Ring)

The TR4050 features a built-in Bell relay that can be used to control an external Bell (see [Bell and Lock control relays](#)). The TR4050 can be programmed to automatically activate the Bell relay at pre-determine times of day. This is done through a [Bell table](#).

The [Bell table](#) may consist of up to 32 time entries. Each entry specifies one time at which the Bell relay will be activated.

Each time the Bell relay is triggered, it remains active for a period of time specified by the [Bell duration](#) Setting.

[Editing Bell and Default Event tables](#) provides complete information on table editing techniques.

C.8. Using Online communications

TR4050 supports online communications and can be controlled directly from the PC.

C.8.1. Online communications with the TR4020

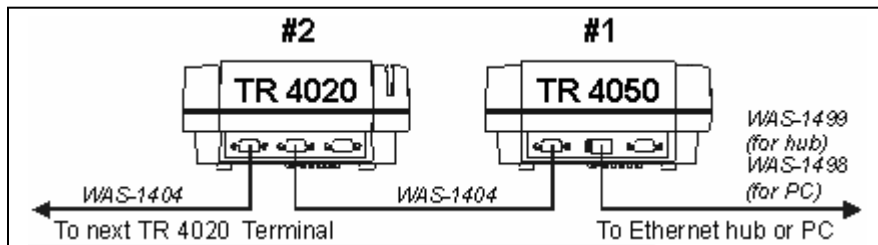

The TR4050 has a built-in TCP/IP Ethernet port so it can be placed on the Local Area Network (LAN) directly. There are two cables supplied with every TR4050: use **WAS-1499** if you want

to connect the TR4050 to the Ethernet hub (normal situation), and **WAS-1498** if you want to connect the Terminal directly to your PC (without any hub). You can also use your own cable, just make sure that you do the wiring correctly- see [Ethernet cable wiring](#) for details.

Each TR4050 must be assigned a unique IP address that is not used by any other device connected to your LAN. Multiple TR4050 Terminals can be placed on a single LAN provided that they all are assigned different IP addresses.

Like the TR4020, the TR4050 has an RS232 Slave port. This port can be used to daisy-chain more TR4020 Terminals (cable **WAS-1404**, see [RS232 cable wiring](#) for details). In this case, the TR4050 can be viewed as a gateway connecting the RS232 daisy-chain network to the LAN. By using this TR4050+TR4020 combination you can place multiple TR40xx clusters onto a single IP-address.

C.8.2. Sample software

ProxData provides a several free software tool- *Time Recorder Utility* and *TR4020/4030 Control Center* for Windows- that you can use to access and control the TR4050 online. You can get these latest version software from the attached disk and these software's *User's Manual* (also available in attached disk) for complete operation instructions.

If you are preparing to design your own TR40xx-related PC software, please refer to a separate document- *TR40xx communications protocol* for a complete protocol description.

C.9. Viewing data on the PC

The data file created by the TR4050 on the USB Disk (or by the *TR4020/4030 Control Center* software or *Time Recorder Utility* on your PC's HDD) has a format known as "delimited text". This kind of files can be processed by a variety of widely available software packages and tools, including the *Microsoft Word, Excel, Access* and many others. Follows are the instructions on how to import the TR4050's Time and Attendance data into the *Microsoft Excel* spreadsheet:

- Launch the *Microsoft Excel*
- Select *File/Open* from the *Main Menu*
- When the *Open* dialog appears, go to the disk/directory that contains the TR4050 file you want to open and select "*All files*" from the *Files of type* drop-down box. This will make the TR4050 data files "visible"
- Double-click on the TR4050 data file to open it- the *Text Import Wizard* dialog will appear
- Click *Finish*- the data will be imported into your spreadsheet

Clicking *Finish* without performing any intermediate steps leaves all the formatting choices to the Excel. We've had no reports of any problems associated with that. You may still want to pass all the Wizard steps manually- there are a lot of formatting options for the date and other fields.

Imported data may look like this:

1	3-Sep-1999	9:10:15	00017468500275	1	1
4	3-Sep-1999	9:50:26	00017468500275	12	1
2	3-Sep-1999	10:31:02	00017468500275	3	1

Fields (left-to-right) are: Event (corresponds to the F-key that was used to register an event), Date, Time, [ID-code](#), Shift, and [Machine Number](#). Note that the TR4050 appends an apostrophe in front of ID-codes. This way Excel will interpret it correctly as a string, not a long number.

C.10. UPS battery

The TR4050 features a built-in UPS (Uninterruptible Power Supply) battery. The battery is capable of supporting the normal operation of the Terminal for 1.5 hours. The battery completely recharges in 72 hours.

It is important to realize that the TR4050 is not a battery-operated device (like a Notebook PC). The battery is provided to aide in the infrequent power outage situations only.

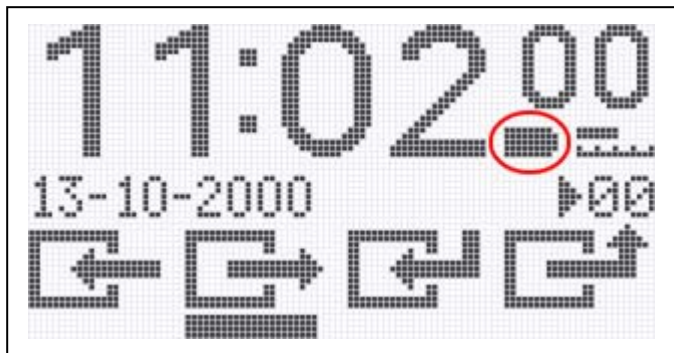

situation remotely.

Whenever the TR4050 is running off internal battery, a Battery icon is displayed on the TR4050 screen in the [Normal Mode](#) (see Figure to the left). The icon can either display a “full” battery (■), or a “low” battery (▢). The TR4050 will only last for about 10 minutes after the “low” battery icon is displayed.

There is also a [Power status](#) Online Item (read-only) provided that lets you inquire the TR4050's current power

Performing USB disk operations such as save file to USB disk is not recommended when running on battery power. This will significantly reduce the battery capacity. In addition, there is a chance that you will run out of power before completing the USB disk operation.

D. Reference

Click on one of the links below:

[All Main Menu Items](#)

[All Online Items](#)

[All Onscreen messages](#)

[Performing a System Reset](#)

[Downloading new application firmware](#)

[Time and Attendance data file format](#)

[Bell and Lock control relays](#)

[I/O Connector pin assignment](#)

[Rotating base cover for desktop operation](#)

[Specifications](#)

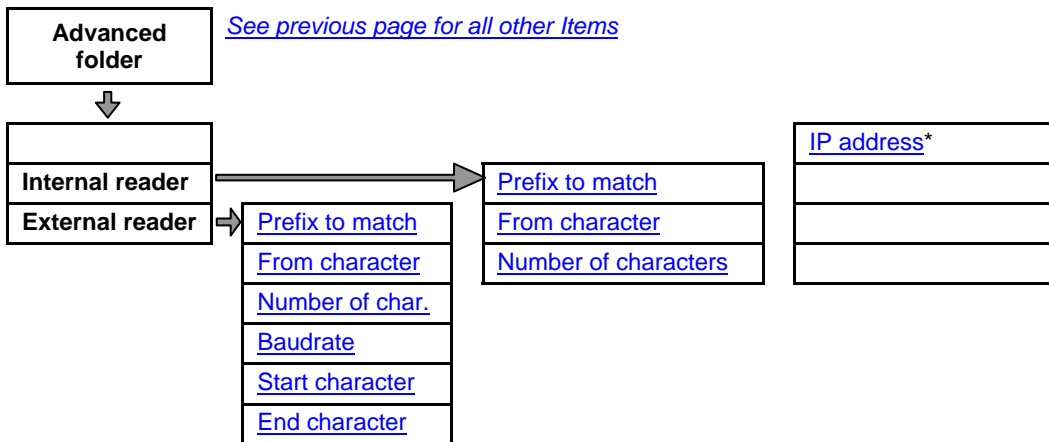

* Note: IP address now is set by utility tool *DS-Manager* (this tool also available in attached disk)

Status report (Main Menu→Database tools)

See also: [Database organization and management](#), [Delete saved data](#), [Mark all as 'new'](#), [Delete all data](#), [Recover data](#)

This command produces a detailed status report, which includes:

- Total number of records in the database (old + new)
- Number of new records
- Total amount of the new data in bytes
- Number of free records
- Database utilization in % (i.e. number of all records/ total database capacity).

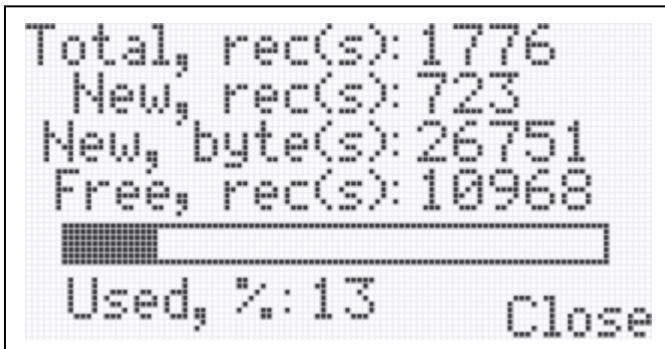

Total amount of new data in bytes deserves some explanation. The database itself keeps the data in records. Each record occupies a pre-defined amount of memory space which does not depend on variable-length fields like ID-code. When you save the data to the USB disk or upload it to the PC, the size of each record will depend on its content. Total new data size in bytes tells you the exact size of the data file (in text format) that will be formed on the USB Disk or PC.

Complete coverage of the TR4050 database organization and related issues can be found in [Database organization and management](#).

Delete saved data (Main Menu→Database tools)

See also: [Database organization and management](#), [Status report](#), [Mark all as 'new'](#), [Delete all data](#), [Recover data](#)

This command erases all the “old” data from the database. Old data is the data that has been saved to the USB disk or uploaded to the PC at least once in the past. Normally, the old data is kept in the database for backup purposes. You can safely erase it when you are sure that you don't need it anymore. This will free up some database space.

Complete coverage of the TR4050 database organization and related issues can be found in [Database organization and management](#).

Mark all as 'new' (Main Menu→Database tools)

See also: [Database organization and management](#), [Status report](#), [Delete saved data](#), [Delete all data](#), [Recover data](#)

Use this command when you want to save the old data again. Old data is the database data that has been saved to USB disk or uploaded to the PC at least once in the past. By default, old data is just kept in the database memory is not saved again and again together with the new data.

Using this command makes all of the TR4050 database data look as new. You will get entire database contents next time you save the data to the USB Disk or upload it to the PC.

Complete coverage of the TR4050 database organization and related issues can be found in [Database organization and management](#).

Delete all data (Main Menu→Database tools)

See also: [Database organization and management](#), [Status report](#), [Delete saved data](#), [Mark all as 'new'](#), [Recover data](#)

This command completely initializes the database. Use it if you want to quickly delete both old and new data. **Delete all data** also repairs the database, so you can use it in case of some database malfunction.

It is noteworthy, that this command does not actually delete the data, it just initializes some internal database housekeeping. If you initialize the database by mistake, you can still (partially) recover its contents by using the [Recover data](#) command.

Complete coverage of the TR4050 database organization and related issues can be found in [Database organization and management](#).

Recover data (Main Menu→Database tools)

See also: [Database organization and management](#), [Status report](#), [Delete saved data](#), [Mark all as 'new'](#), [Delete all data](#)

This command can be used to (partially) recover the database contents after the database was damaged or inadvertently initialized using the [Delete all data](#) command.

After this command, the TR4050 internal database appears to be 100% full with new records. Hence, saving the data to USB disk or uploading it to the PC after this will fetch entire database memory contents. Naturally, some of the recovered data will be invalid, newer records may overlap older ones, etc. Nevertheless, **Recover data** command may be your last chance to recover lost data.

Note: do not forget to use the [Delete all data](#) command after having finished the recovery process.

Complete coverage of the TR4050 database organization and related issues can be found in [Database organization and management](#).

LCD contrast (Main Menu→Setup)

See also:---

This Setting allows you to adjust the contrast ratio of the TR4050 LCD screen. Use **Lighter (F2)** and **Darker (F3)** keys to adjust the contrast

Machine No (Main Menu→Setup)

See also: [Viewing data on the PC](#), [Time and Attendance data file format](#)

Machine Number is used to distinguish between the data generated by individual TR4050 Terminals. It is a part of every Time and Attendance record generated by the TR4050.

Machine Number can be in the 00-99 range.

Note: Machine Number is NOT the Terminal's network number.

Default value for this Setting is 1.

Master ID & Master Fingerprint (Main Menu→Setup)

See also: [Powering up for the first time](#), [Programming Mode](#), [Master password](#)

Master ID (Master Card) or **Master Fingerprint** is a supervisor ID-code that is used to access the TR4050's [Programming Mode](#). Together with an optional [Master password](#), it protects the Terminals internal Settings and data from unauthorized viewing or editing.

Initially, you choose the **Master ID** or **Master Fingerprint** when you switch the TR4050 on for the first time (see [Powering up for the first time](#)).

This Setting allows you to set a new (change) **Master ID** or **Master Fingerprint**.

When the **Read the card you wish to use as the Master Card** message appears, read the card or fingerprint of your choice to set a new ID-code (or press **Abort** to exit).

New **Master ID** Setting is effective immediately- use the new Card to access the [Programming Mode](#) from that moment on.

Master password (Main Menu→Setup)

See also: [Master ID & Master Fingerprint](#), [Programming Mode](#)

Master password provides an additional [Programming Mode](#) protection. When the **Master password** is set, you need to both read a valid [Master ID](#) or [Master Fingerprint](#) and input correct **Master password** in order to enter the [Programming Mode](#).

To make sure that you don't make any typo when entering a new password, you'll need to input it twice: first time when the TR4050 displays **Input new Master Password**, second time when the TR4050 requests you to **Re-type Master Password**. You must enter an exact same password both times or the password will not be set.

The password may be from 0 to 6 digits long.

To disable Master password, enter the password of 0 length: when the TR4050 asks you if you wish to disable **Master password**, answer **Yes**. The password will be disabled.

By default, the **Master password** is not set.

Date (Main Menu→Setup)

See also: [Time](#)

This Menu Item allows you to set the TR4050's current date. Note, that the date must be added in the *dd-mm-yyyy* format, or the Terminal won't accept it.

Time (Main Menu→Setup)

See also: [Date](#)

This Menu Item allows you to set the TR4050's current date.

Bell duration (Main Menu→Setup)

See also: [Edit bell table](#), [Clear bell table](#), [Controlling external Bell \(Ring\)](#), [Bell and Lock control relays](#)

The TR4050 is equipped with a bell control relay (see [Bell and Lock control relays](#)) that can be used to activate an external Bell (Ring) at certain predefined daytimes. Bell activation schedule is defined by the Bell table (see [Edit bell table](#), [Controlling external Bell \(Ring\)](#)).

The **Bell duration** Setting defines for how long the bell will be activated each time it is triggered. The value may be in the 00-99 seconds range. Setting the **Bell duration** to 00 effectively disables the Bell function.

Default value for this Setting is 10.

Edit bell table (Main Menu→Setup)

See also: [Bell duration](#), [Clear bell table](#), [Controlling external Bell \(Ring\)](#), [Bell and Lock control relays](#)

The TR4050 is equipped with a bell control relay (see [Bell and Lock control relays](#)) that can be used to activate an external Bell (Ring) at certain predefined daytimes. This function allows you to define up to 32 different daytimes at which the bell control relay will be switched on.

The **Bell table** consists of entries, each of which has a single field: the activation time. The amount of time that relay will remain activated once triggered is defined by the [Bell duration](#) Setting together for all entries. It is not possible to set a define durations separately for individual **Bell table** entries.

Edit bell table allows you to add, edit and delete individual entries. You can quickly erase entire table using [Clear bell table](#) Menu Item. [Editing Bell and Default Event tables](#) explains how to edit TR4050 Tables.

Clear bell table (Main Menu→Setup)

See also: [Bell duration](#), [Edit bell table](#), [Controlling external Bell \(Ring\)](#), [Bell and Lock control relays](#)

This command allows you to quickly erase the contents of the **Bell table**.

Edit default event table (Main Menu→Setup)

See also: [Clear default event table](#), [Speeding up User registration](#)

The TR4050 allows you to define a so-called default event schedule. When this schedule is defined, the TR4050 will be automatically pre-selecting the appropriate event key (IN, OUT, etc...) depending on the time of day. This way, User registration can be made more efficient (see [Speeding up User registration](#)).

The **Default Event table** consists of entries, each of which contains two fields: beginning time of a timezone, and a default event for this timezone. Details on how to use the table may be found in [Using Default Event Table](#).

You can quickly erase entire table using [Clear default event table](#) Menu Item.

Clear default event table (Main Menu→Setup)

See also: [Edit default event table](#), [Speeding up User registration](#)

This command allows you to quickly erase the contents of the **Default Event table**.

Default shift (Main Menu→Setup)

See also: [Speeding up User registration](#)

The TR4050 allows you to define a default shift that will be automatically pre-selected for User convenience. This way the User registration can be made more efficient (see [Speeding up User registration](#)).

Default shift sets a shift number that the TR4050 will return to after then User reads his/her ID-card or fingerprint or after several seconds of inactivity. Setting 00 disables the function- the TR4050 will always keep the last shift number entered by the User.

Default setting value is 0 (i.e. the function is disabled).

Lock activation duration (Main Menu→Setup)

See also: [Bell and Lock control relays](#), [Using the TR4050 as an Access Control Terminal](#)

The TR4050 features an electric lock control relay (see [Bell and Lock control relays](#)). Relay is activated *every time* a valid User ID-code is read (ID-Card or fingerprint). This can be used to enforce User Registration process (by denying User access to the facility without registration) and even for a simple access control function implementation (see [Using the TR4050 as an Access Control Terminal](#)).

Lock activation duration setting defines for how long the lock control relay will remain activated once triggered. Valid value range is 00-99 seconds. Selecting 0 effectively disables the function.

Default value for this Setting is 0.

IP address

See also: [Online communications with the TR4050](#)

This Item defines the Terminal's IP address on a Local Area Network (LAN). To set the IP address for TR4050 now is via Tool program- *DS Manager* which is available in attached disk. Please install *DS manager* first then launch it to set IP address for TR4050. Each TR4050 must be assigned a **unique** IP address. It is a common convention to write the IP address in a so-called "dot notation", i.e. "192.168.100.40". Consult with your Network Administrator to determine the suitable IP address for each TR4050 you are planning to install on the network. Note, that the matching IP address must also be set in the PC software you are using to control the TR4050. Default value for this setting is "127.0.0.1".

Prefix to match (Main Menu→Setup→Advanced...→Internal reader)

See also: [From character](#), [Number of characters](#), [Fine-tuning ID-code processing](#), [Using the TR4050 as an Access Control Terminal](#).

Note: The explanation below applies to the TR4050's internal reader. There is an identical Setting for an external reader (scanner)- see [Prefix to match \(External reader\)](#)

Prefix to match allows you to restrict the User ID-code (ID-cards or fingerprint) accepted by the TR4050 to cards or fingerprint whose leading ID-code characters match those of the prefix string. This way you can setup the System to accept only certain ID-code (ID-cards or fingerprint) (see [Fine-tuning ID-code processing](#)). You can even implement a simple access control function ([Using the TR4050 as an Access Control Terminal](#)).

The prefix string can be from 0 to 16 digits long. Entering a string with 0 characters disables prefix checking- any readable User ID-code (ID-cards or fingerprint) will be accepted. If the prefix string is set, the TR4050 will compare each User ID-code (ID-cards or fingerprint) with this string and reject the ID-code that do not match, for example:

If **Prefix to match** is set to "123" then the TR4050 will accept ID-code such as "1234", "123679", "123". The Terminal will reject the ID-codes like "14377" and "12".

Default value for this setting is "" (empty string), i.e. prefix matching is disabled.

From character (Main Menu→Setup→Advanced...→Internal reader)

See also: [Prefix to match](#), [Number of characters](#), [Fine-tuning ID-code processing](#), [Using the TR4050 as an Access Control Terminal](#).

Note: The explanation below applies to the TR4050's internal reader. There is an identical Setting for an external reader (scanner)- see [From character \(External reader\)](#).

From character, together with [Number of characters](#) Setting allows you to extract and store into the database a portion of code from the User ID-card or fingerprint instead of the entire ID-code. This way you can adjust the format of the data generated by the TR4050 to the requirements of some specific PC software (see [Fine-tuning ID-code processing](#)). You can also use this Setting to “hide” a certain portion of the ID-card code or Fingerprint code. This is useful for a simple access control function implementation (see [Using the TR4050 as an Access Control Terminal](#)).

From character defines a character position in the ID-code (counting from 1), starting from which the portion of an ID-code will be extracted. The valid range for this Setting is from 1 to 40. The TR4050 will reject any User ID-code (ID-Card or Fingerprint) with the number of characters in it smaller then current **From character** value.

Example: supposing that From character=3 and Number of characters=2. Then, ID-code “123456” will be truncated to “34”, ID-code “123” will become “3”, and ID-code “12” will be rejected.

Default value for this Setting is 1.

Number of characters (Main Menu→Setup→Advanced...→Internal reader)

See also: [Prefix to match](#), [From character](#), [Fine-tuning ID-code processing](#), [Using the TR4050 as an Access Control Terminal](#).

Note: The explanation below applies to the TR4050's internal reader. There is an identical Setting for an external reader (scanner)- see [Number of characters \(External reader\)](#).

Number of characters, together with [From character](#) Setting allows you to extract and store into the database a portion of code from the User ID-code (ID-card's or Fingerprint's code) instead of the entire ID-code. This way you can adjust the format of the data generated by the TR4050 to the requirements of some specific PC software (see [Fine-tuning ID-code processing](#)). You can also use this Setting to "hide" a certain portion of the ID-code (ID-card's or Fingerprint's code). This is useful for a simple access control function implementation (see [Using the TR4050 as an Access Control Terminal](#)).

Number of characters defines the length of the portion of code that will be extracted from the ID-code starting from the [From character](#) position. The valid value range for this Setting is from 1 to 40. Actual number of extracted characters can be smaller then that defined by the **Number of characters** Setting. This happens when ([From character](#) + **Number of characters** - 1) > length of ID-code. Examples:

If [From character](#)=2 and **Number of characters**=3 then ID-code "12345" will produce "234", and ID-code "123" will result in "23" only.

Default value for this Setting is 40.

Prefix to match (Main Menu→Setup→Advanced...→External reader)

See also: [From character](#), [Number of characters](#), [Fine-tuning ID-code processing](#), [Using the TR4050 as an Access Control Terminal](#).

Note: The explanation below applies to the TR40xx's external reader. There is an identical Setting for an internal reader- see [Prefix to match \(Internal reader\)](#).

Prefix to match allows you to restrict the User ID-code (ID-cards or fingerprint's code) accepted by the TR4050 to ID-code whose leading ID-code characters match those of the prefix string. This way you can setup the System to accept only certain ID-code (ID-cards or fingerprint's code) (see [Fine-tuning ID-code processing](#)). You can even implement a simple access control function ([Using the TR4050 as an Access Control Terminal](#)).

The prefix string can be from 0 to 16 digits long. Entering a string with 0 characters disables prefix checking- any readable ID-code (User card or fingerprint's code) will be accepted. If the prefix string is set, the TR4050 will compare each ID-code (User card or fingerprint's code) with this string and reject the ID-code that do not match, for example:

If **Prefix to match** is set to "123" then the TR4050 will accept cards such as "1234", "123679", "123". The Terminal will reject the ID-code like "14377" and "12".

Default value for this setting is "" (empty string), i.e. prefix matching is disabled.

From character (Main Menu→Setup→Advanced...→External reader)

See also: [Prefix to match](#), [Number of characters](#), [Fine-tuning ID-code processing](#), [Using the TR4050 as an Access Control Terminal](#).

Note: The explanation below applies to the TR4050's external reader (scanner). There is an identical Setting for an internal reader- see [From character](#).

From character, together with [Number of characters](#) Setting allows you to extract and store into the database a portion of code from the User ID-code (User ID-card's or fingerprint's code) instead of the entire ID-code (User ID-card's or fingerprint's code). This way you can adjust the format of the data generated by the TR4050 to the requirements of some specific PC software (see [Fine-tuning ID-code processing](#)). You can also use this Setting to "hide" a certain portion of the ID-code. This is useful for a simple access control function implementation (see [Using the TR4050 as an Access Control Terminal](#)).

From character defines a character position in the ID-code (counting from 1), starting from which the portion of an ID-code will be extracted. The valid range for this Setting is from 1 to 40. The TR4050 will reject any User ID-code (User ID-card's or fingerprint's code) with the number of characters in it smaller then current **From character** value.

Example: supposing that From character=3 and Number of characters=2. Then, ID-code "123456" will be truncated to "34", ID-code "123" will become "3", and ID-code "12" will be rejected.

Default value for this Setting is 1.

Number of character (Main Menu→Setup→Advanced...→External reader)

See also: [Prefix to match](#), [From character](#), [Fine-tuning ID-code processing](#), [Using the TR4050 as an Access Control Terminal](#).

Note: The explanation below applies to the TR4050's external reader (scanner). There is an identical Setting for an internal reader- see [Number of characters](#).

Number of characters, together with [From character](#) Setting allows you to extract and store into the database a portion of ID-code from the User ID-card's or Fingerprint's code instead of the entire ID-code. This way you can adjust the format of the data generated by the TR4050 to the requirements of some specific PC software (see [Fine-tuning ID-code processing](#)). You can also use this Setting to "hide" a certain portion of the ID-card's or Fingerprint's code. This is useful for a simple access control function implementation (see [Using the TR4050 as an Access Control Terminal](#)).

Number of characters defines the length of the portion of code that will be extracted from the ID-code starting from the [From character](#) position. The valid value range for this Setting is from 1 to 40. Actual number of extracted characters can be smaller then that defined by the **Number of characters** Setting. This happens when ([From character](#) + **Number of characters** - 1) > length of ID-code. Examples:

If [From character](#)=2 and **Number of characters**=3 then ID-code "12345" will produce "234", and ID-code "123" will result in "23" only.

Default value for this Setting is 40.

Baudrate (Main Menu→Setup→Advanced...→External reader)

See also: [Prefix to match](#), [From character](#), [Number of characters](#), [Start character](#), [End character](#), [Working with external scanner](#)

The TR4050 features an external reader (scanner) port that can be used to attach an auxiliary device. Reading the card on the external device generates a Time and Attendance record in exactly the same manner as with the internal (built-in) reader.

Baudrate defines the speed setting for the external reader (scanner) port. Possible values for this Setting and their corresponding baud rates are listed below:

0	1200 bps
1	2400 bps
2	4800 bps
3	9600 bps
4	19200 bps

All other serial port parameters are fixed at 8 bits, no parity, 1 stop bit.

Default value for this Setting is 3 (9600 bps).

Start character (Main Menu→Setup→Advanced...→External reader)

See also: [Prefix to match](#), [From character](#), [Number of characters](#), [Baudrate](#), [End character](#), [Working with external scanner](#)

The TR4050 features an external reader (scanner) port that can be used to attach an auxiliary device. Reading the card on the external device generates a Time and Attendance record in exactly the same manner as with the internal (built-in) reader.

The TR4050 expects the data from an external reader to arrive enclosed in a **Start character** and [End character](#). All characters between these two are considered to be the ID-code itself (there is a limitation on the maximum length of data that the TR4050 will accept- see [Working with external scanner](#)).

Start character Setting defines the ASCII code of the start character. Once the TR4050 encounters the **Start character**, it starts receiving the data that follows until the [End character](#) code is encountered. If the **Start character** code is received again, then all the data that followed the previously received Start character is discarded. Examples :

If the **Start character**="A" and the [End character](#)=B then the "A12345B" string from the external scanner will generate a record with the ID-code field containing "12345"; "A123A45B" will result in "45" ("123" will be discarded).

Default value for this setting is 02 (this is STX, a very command start character code).

End character (Main Menu→Setup→Advanced...→External reader)

See also: [Prefix to match](#), [From character](#), [Number of characters](#), [Baudrate](#), [Start character](#), [Working with external scanner](#)

The TR4050 features an external reader (scanner) port that can be used to attach an auxiliary device. Reading the card on the external device generates a Time and Attendance record in exactly the same manner as with the internal (built-in) reader.

The TR4050 expects the data from an external reader to arrive enclosed in a [Start character](#) and **End character**. All characters between these two are considered to be the ID-code itself (there is a limitation on the maximum length of data that the TR4050 will accept- see [Working with external scanner](#)).

End character Setting defines the ASCII code of the end character. Examples:

If the **Start character**="A" and the [End character](#)=B then "A12345B" string from the external scanner will generate a record with the ID-code field containing "12345".

Default value for this setting is 13 (this is Carriage Return character).

D.2. All Online Items

D.2.1. List of Online Items

Depending on the firmware you are using, some items below may not be available on your Machine.

<u>Online Item</u>	<u>Corresponding Programming Mode Setting/Screen</u>
Machine Number	Machine No
Machine Name	This Item is only available online
Time	Time
Date	Date
Login Password	This Item is only available online
Bell duration	Bell duration
Bell Table	Edit bell table , Clear bell table
Default Event Table	Edit default event table , Clear default event table
Default shift	Default shift
Lock activation duration	Lock activation duration
Internal reader, prefix	Prefix to match (Internal reader)
Internal reader, extract from character	From character (Internal reader)
Internal reader, num. of chars. to extract	Number of character (Internal reader)
External scanner, prefix	Prefix to match (External reader)
External scanner, extract from character	From character (External reader)
External scanner, num. of chars. to extract	Number of character (External reader)
External scanner, start character	Start character (External reader)
External scanner, end character	End character (External reader)
External scanner, baudrate	Baudrate (External reader)
Total number of records , Number of new records , Number of free records	Reported by Status report command
Power status	Power icon in the Normal Mode (see UPS battery)
Firmware version	Version is displayed at the Terminal startup (see Checking currently loaded firmware version)

Machine Number

See [Machine Number](#) ([Programming Mode](#) Menu Item).

Machine Name

See also: [Machine Number](#)

This Item allows you to define a name for Terminal. The name exists for your convenience only (to make it easier for you to select a Terminal from the list of all available Terminals). **Machine name** does not go into the Time and Attendance database records, only [Machine Number](#) does.

Machine name can be from 0 to 16 characters long.

Default value for this Item is "" (empty string).

Time

See [Time](#) ([Programming Mode](#) Menu Item).

Date

See [Date](#) ([Programming Mode](#) Menu Item).

Login Password

See also: [Using Online communications](#)

Login Password protects online access to the TR4050. Online User must login onto the Terminal using the **Login Password** first. Only then he will be able to edit the TR4050's Items or upload the Time and Attendance database.

Login Password can be from 0 to 8 characters long. The User needs to perform a login even when the password is not set (i.e. it has zero characters).

Default value for this Item is "" (empty string).

Bell duration

See [Bell duration](#) ([Programming Mode](#) Menu Item).

Bell Table

See [Edit bell table](#), [Clear bell table](#) ([Programming Mode](#) Menu Items).

Default Event Table

See [Edit default event table](#) and [Clear default event table](#) ([Programming Mode](#) Menu Items).

Default shift

See [Default shift \(Programming Mode Menu Item\)](#).

Lock activation duration

See [Lock activation duration \(Programming Mode Menu Item\)](#).

Internal reader, prefix

See [Prefix to match](#) ([Programming Mode](#) Menu Item).

Internal reader, extract from character

See [From character](#) ([Programming Mode](#) Menu Item).

Internal reader, number of characters to extract

See [Number of characters](#) ([Programming Mode](#) Menu Item).

External scanner, prefix

See [Prefix to match](#) ([Programming Mode](#) Menu Item).

External scanner, extract from character

See [From character](#) ([Programming Mode](#) Menu Item).

External scanner, number of characters to extract

See [Number of character](#) ([Programming Mode](#) Menu Item).

External scanner, start character

See [Start character \(Programming Mode Menu Item\)](#).

External scanner, end character

See [End character](#) ([Programming Mode](#) Menu Item).

External scanner, baudrate

See [Baudrate \(Programming Mode Menu Item\)](#).

Total number of records

See also: [Status report](#), [Database organization and management](#)

This Item is read-only. It returns the total number of records (old + new) currently found in the TR4050's database. This is the same value that is displayed by the [Status report](#) screen's **Total, rec(s)**.

Complete coverage of the TR4050 database organization and related issues can be found in [Database organization and management](#).

Number of new records

See also: [Status report](#), [Database organization and management](#)

This Item is read-only. It returns the total number of new records currently found in the TR4050's database. This is the same value that is displayed by the [Status report](#) screen's **New, rec(s)**.

Complete coverage of the TR4050 database organization and related issues can be found in [Database organization and management](#).

Number of free records

See also: [Status report](#), [Database organization and management](#)

This Item is read-only. It returns the total number of free (unused) records currently found in the TR4050's database. This is the same value that is displayed by the [Status report](#) screen's **Free, rec(s)**.

Complete coverage of the TR4050 database organization and related issues can be found in [Database organization and management](#).

Power status

See also: [UPS battery](#)

This Item is read-only. It reports current TR4050 power situation. Possible returned values are:

0	Wall power
1	Battery power, battery level is OK
2	Battery power, battery level is low

Firmware version

See also: [Downloading new application firmware](#)

This Item is read-only. It returns currently loaded firmware version. This is the same string that is displayed at the TR4050 startup (see [Checking currently loaded firmware version](#) of [Downloading new application firmware](#) for more details)

D.3. All Onscreen messages

D.3.1. List of all messages

[Amount of Flash memory installed is not enough to run this application. Machine is halted](#)
[Before you can start using this machine... you need to set a Master Card. Read any card now- it will...](#)
[Database error. New data cannot be added](#)
[Database error. Operation will be aborted](#)
[Database is full. New data cannot be added](#)
[Do you wish to disable Master Password?](#)
[Do you wish to exit programming mode?](#)
[Do you wish to proceed with this operation?](#)
[Firmware error. Machine is halted](#)
[Flash memory failure or Flash is not installed. Machine is halted.](#)
[I/O board communications error. Machine is halted. Performing System Reset may help \(TR4050 only\)](#)
[I/O board failure. Machine is halted \(TR4050 only\)](#)
[ID-code is too long. New data cannot be added](#)
[Incorrect Password](#)
[Initializing...](#)
[Input Master Password](#)
[Input new Master Password](#)
[Invalid card](#)
[Invalid setting value has been encountered. Machine is halted](#)
[Machine has been reset. You may now switch it off](#)
[Machine is running on battery power. Performing disk tasks is not recommended. Continue still?](#)
[Online session is in progress. Entering Programming Mode will abort it. Continue still?](#)
[Passwords do not match. New Master Password was not set](#)
[Please, wait...](#)
[Read a card you wish to use as the Master Card](#)
[Reader failure. Machine is halted](#)
Continued on the next page...

Real-Time Clock failure. Machine is halted

Re-type Master Password

The data you have entered is invalid

The menu is empty

Time/date is not set. New data cannot be added

Timetable is full

Total, rec(s): XXX New, rec(s): XXX New, byte(s): XXX Free, rec(s): XXX Used, %: XXX

Unsupported I/O board. Machine is halted

You will now enter Programming Mode

Amount of Flash memory installed is not enough to run this application. Machine is halted

See also:---

This message indicates that the application firmware you have downloaded needs more FLASH memory than you have on your TR4050. It is highly unlikely that you'll ever see this message. If this happens, please contact us as promag@gigatms.com.tw.

Before you can start using this machine... you need to set a Master Card. Read any...

See also: [Powering up for the first time](#), [Programming Mode](#), [Performing a System Reset](#), [Master ID](#)

This message is displayed when you switch the TR4050 on for the first time ever or after having performed a [System reset](#). The Master ID-card or Master Fingerprint is used to access a [Programming Mode](#). Setting it is a required step, which cannot be skipped. Read the card or fingerprint of your choice- this Card or fingerprint will be recognized as the Master ID-code from now on. You can always change the Master IC-code by using the [Master ID](#) command.

Database error. New data cannot be added

See also: [Delete all data](#), [Recover data](#), [Database organization and management](#)

This message appears when the database is malfunctioning and the User attempts to register (read User ID-card or fingerprint). New records cannot be added to the database until it is repaired. You can repair the database either by initializing it ([Delete all data](#) command) or recovering it ([Recover data](#) command).

Please, refer to the [Database organization and management](#) Section for complete coverage of the database organization and related issues.

Database error. Operation will be aborted

See also: [Delete all data](#), [Recover data](#), [Database organization and management](#)

This message means that the Time and Attendance database is malfunctioning and the operation you've attempted to perform cannot be finished. You can repair the database either by initializing it ([Delete all data](#) command) or recovering it ([Recover data](#) command).

Please, refer to the [Database organization and management](#) Section for complete coverage of the database organization and related issues.

Database is full. New data cannot be added

See also: [Database organization and management](#), [Delete saved data](#), [Delete all data](#)

This message appears when the database is full already and the User attempts to register (read User ID-card or fingerprint). New records cannot be added unless the database is (partially) emptied. You can do this either by deleting the old (saved) database data ([Delete saved data](#) command), or by delete all database data ([Delete all data](#)).

Please, refer to the [Database organization and management](#) Section for complete coverage of the database organization and related issues.

Do you wish to disable Master Password

See also: [Master password](#), [Programming Mode](#)

This message is displayed when you input a 0-length password for the [Master password](#) Setting. The TR4050 double checks with you by asking you to confirm if you really want to disable the password. Choosing **Yes** will disable the [Master password](#), choosing **No** will preserve the password intact.

Do you wish to exit programming mode?

See also: [Programming Mode](#)

This question is asked when you are about to leave the [Programming Mode](#). Press No to return to the Main Menu, Yes- to exit the [Programming Mode](#).

Do you wish to proceed with this operation?

See also: [Delete saved data](#), [Mark all as 'new'](#), [Delete all data](#), [Recover data](#)

This confirmation screen is displayed whenever you are about to execute a command that will irreversibly alter or delete the data in the Terminal's memory. Make sure you really know what you are doing and press **Yes** to continue or **No** to safely abort command execution.

Firmware error. Machine is halted

See also:---

In an unlikely event that you ever face this message, please contact us at promag@gigatms.com.tw.

Flash memory failure or Flash is not installed. Machine is halted

See also:---

This is a severe error that indicates some internal hardware malfunction. Please, return your TR4050 for service/ repair.

I/O board communications error. Machine is halted. Performing System...**TR4050 only**

This message indicates that there is something wrong with the I/O board (Ethernet adaptor) of the TR4050. The problem may be with the board's hardware or internal firmware. Since the firmware of the I/O board is re-loaded each time you perform a [System Reset](#), doing so may solve the problem. If [System Reset](#) doesn't help, send the TR4050 for repairing.

I/O board failure. Machine is halted**TR4050 only**

This message indicates that I/O board (Ethernet adaptor) of the TR4050 is malfunctioning. Send the TR4050 for repairing.

ID-code is too long. New data cannot be added

See also: [From character](#), [Number of characters](#), [Baudrate](#), [Start character](#), [End character](#), [Working with external scanner](#).

This message may be displayed when you are using an external reader (scanner). The message means that ID-code contained too many characters. The limitation for the TR4050 is 20 alphanumeric or 40 numerical (Hex) characters. "Hex Numerical" means that the ID-code only contained digits from '0' to '9' and characters from 'A' to 'F' (capitals only). If the ID-code contained at least one other character, then it is considered to be alphanumeric. Example: "12F9B" is numerical, it can be up to 40 characters long. "12F9b" is alphanumeric (because of 'b' character), so it must be limited to 20 characters only.

The TR4050 provides several Settings that allow you to process the ID-code from external reader. You can extract a smaller code portion by using [From character](#) and [Number of characters](#) Settings. See [Working with external scanner](#) for more details.

If you are pretty sure that the code from external reader cannot exceed the maximum lengths specified above, then the problem may be in the external port settings. Check [Baudrate](#), [Start character](#), and [End character](#) Settings to make sure that everything is set up correctly.

Incorrect Password

See also: [Entering Programming Mode](#), [Master password](#)

This message is displayed when you have entered an incorrect [Master password](#).

Initializing...

The [System Reset](#) is in progress. Please, wait for a while...

Input Master Password

See also: [Entering Programming Mode](#), [Master password](#)

This message is displayed after you read the Master ID-card or Master Fingerprint in case the [Master password](#) is set. Input correct password and press **Enter**.

Input new Master Password

See also: [Entering Programming Mode](#), [Master password](#)

This message is displayed when you choose to input new [Master password](#). Input any password of up to 6 characters long and press **Enter**.

Invalid card

See also: [Prefix to match](#), [From character](#), [Number of characters](#), [Fine-tuning ID-code processing](#)

The following applies both to the internal and external readers.

This message is displayed when the User ID-card or fingerprint is rejected by the TR4050. This can be because of two reasons:

- The ID-code of the User's ID-card or User's fingerprint does not match the [Prefix](#)
- The ID-code of the User's ID-card or User's fingerprint is shorter than the value set in the [From character](#) Setting, so processing the ID-card or fingerprint produces an ID-code of zero length, which is not allowed

Invalid setting value has been encountered. Machine is halted

See also: [Performing a System Reset](#)

This message indicates that some TR4050's Setting contains an invalid value. Normally, this situation can be solved by performing a [System Reset](#). You can do this safely, since reset will preserve the database data of the TR4050 intact.

If the problem persists, contact us at promag@gigatms.com.tw.

Machine has been reset. You may now switch it off

See also: [Performing a System Reset](#)

This message is displayed when the [System Reset](#) is over. Simply switch the TR4050 off and back on again to continue.

Machine is running on battery power! Performing disk tasks is not recommended! Continue still?

See also: [UPS battery](#)

This command is displayed whenever you attempt to perform some USB disk operation while the TR4050 is running on battery power. Doing this is not recommended because the USB Disk Port consumes high power. Therefore, remaining battery charge will be depleted faster. Also, there is a chance that the battery will run out of power before the USB disk operation completes.

Online session is in progress. Entering Programming Mode will abort it. Continue still?

See also: [Programming Mode](#), [Using Online communications](#)

This message is displayed when you are about to enter the [Programming Mode](#) while there is an Online User logged onto the TR4050.

If you choose **Yes**, then the Online User will be disconnected from the Terminal (kicked-out). Choosing **No** will abort your attempt to enter the [Programming Mode](#).

Passwords do not match. New Master Password was not set

See also: [Master password](#), [Programming Mode](#)

When you attempt to set a new [Master password](#), you are requested to input the same password twice. This is to make sure that you haven't made any typo. This message is displayed when password you have entered first does not match the password you have entered the second time.

Please, wait...

Just wait for a while... :)

Read a card you wish to use as the Master Card

See also: [Master ID](#)

This message is displayed when you are about to set new [Master ID](#) Card or [Master Fingerprint](#). Simply read the card of your choice or press **Cancel** to abort this operation. This screen will also timeout automatically in about 20 seconds.

Reader failure. Machine is halted

See also:---

This is a severe error that indicates some internal hardware malfunction. Please, return your TR4050 for service/ repair.

Real-Time Clock failure. Machine is halted

See also:---

This is a severe error that indicates some internal hardware malfunction. Please, return your TR4050 for service/ repair.

Re-type Master Password

See also: [Master password](#), [Entering Programming Mode](#)

This message is displayed when you are setting a new [Master password](#). To make sure that you haven't made any typo, you are required to input the same password string twice. Just input the same string again and press **Enter**.

The data you have entered is invalid

See also: [Programming Mode](#)

This message is displayed when you input an invalid new setting value, for example 13:10:65 for the [Time](#) Setting.

The menu is empty

See also:---

In an unlikely event that you ever face this message, please contact us at promag@gigatms.com.tw.

To continue working, simply press **Close**.

Time/date is not set. New data cannot be added

See also: [Time](#), [Date](#), [Programming Mode](#)

This error is displayed when the User reads his/her ID-card or fingerprint and the TR4050 doesn't have its internal Real-Time Clock set to a correct value. Enter the [Programming Mode](#) and use the [Time](#) and [Date](#) Settings to set the Real-Time Clock. Only then the TR4050 will allow the Users to register.

Timetable is full

See also: [Edit bell table](#), [Edit default event table](#), [Editing Bell and Default Event tables](#)

The **Bell** and **Default Event** tables of the TR4050 can both contain not more than 32 entries (records) each. This message is displayed when you attempt to add the 33rd record to either table.

Total, rec(s): XXX New, rec(s): XXX New, byte(s): XXX Free, rec(s): XXX Used, %: XXX

See also: [Status report](#), [Database organization and management](#)

This screen is displayed when you execute the [Status report](#) command. Complete coverage of database-related issues as well as explanation for the data displayed by this screen can be found in [Database organization and management](#).

Unsupported I/O board. Machine is halted

This message indicates that your TR4050 terminal's current firmware cannot support the installed I/O board. Please, contact us by Email promag@gigatms.com.tw to obtain the latest version of the firmware that will be recognize your I/O board.

You will now enter Programming Mode

See also: [Powering up for the first time](#), [Programming Mode](#), [Performing a System Reset](#)

This screen is displayed after you choose the Master Card or Master Fingerprint on the [first time you switch the TR4050 on](#) or after the [System Reset](#). This is just an information screen- read it and press **F4** to continue- you will find yourself in the [Programming Mode](#).

D.4. Performing a System Reset

System Reset restores all TR4050 Settings to their default factory state but preserves the database contents. System Reset is the only solution in case you loose the Master Card (or fingerprint) or forget the Master Password; also when the TR000 displays any message that says “Machine is halted”.

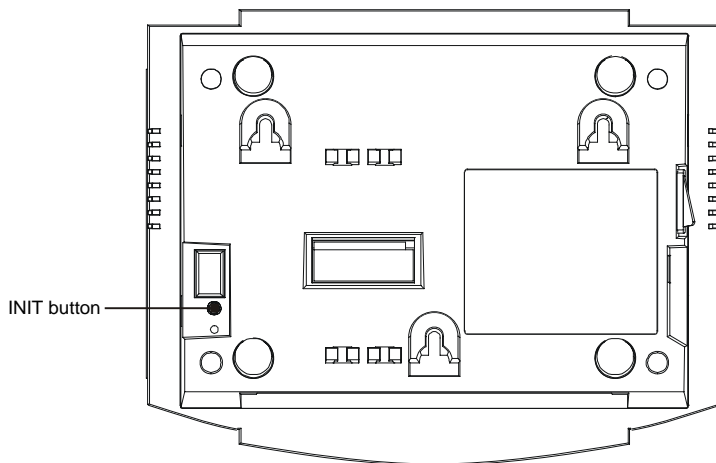

To perform the System Reset:

- Switch the TR4050 off
- Press and hold INIT button with any sharp object (location shown on Figure above)
- Switch the TR4050 back on and wait till the TR4050 beeps and displays “**Please, wait...**”
- Release the button and wait for “**Machine has been reset. You may now switch it off**”
- Switch the TR4050 off and then back on again. See [Powering up for the first time](#) for further steps.

D.5. Downloading new application firmware

The TR4050's internal firmware can be upgraded in the field via a so-called Application Download Port.

D.5.1. Obtaining the most recent firmware version

We are constantly working on the TR4050 functionality enhancement. You are advised to contact us at promag@gigatms.com.tw so we can let you get when the new improved firmware version is available.

D.5.2. Checking currently loaded firmware version

Before attempting to install a new firmware, always check the firmware that is currently loaded into your TR4050. All firmware versions developed by the ProxData are assigned ascending version numbers. The TR4050 displays the version number of the currently loaded firmware at the startup. The Monitor screen displayed for a couple of seconds after the power-up looks somewhat like this:

```
MONITOR (v3.1G)
Starting app:
TimeRd V3.70G
Please, wait...
```

Third line in the screen above displays current firmware version ("TimeRd V3.70G"). If you want to get the latest version of the firmware you can contact us at promag@gigatms.com.tw we will let you get the latest version of the firmware and you think that new features offered are useful to you, then you can upgrade your TR4050.

D.5.3. Downloading new firmware file

The application file is downloaded onto the TR4050 using a special Download Cable, a standard Serial Cable (both included with every TR4050), and a PC running any communications software supporting a XMODEM protocol (checksum version). Suitable software packages are *Term95* (part of *Norton Commander* package), *QMODEM* (a very popular *DOS* program), and a *HyperTerminal*. The latter is

especially popular because it comes with every *Windows-95/98/2000* distribution. Procedures below assume the use of *HyperTerminal* for *Windows-98*.

The *HyperTerminal* is normally found in *Start* → *Programs* → *Accessories* → *Communications* → *HyperTerminal* folder. If it is not there, then you must have opted it out when installing *Windows* on your PC. Follow the instructions below to add *HyperTerminal* to your system (be sure to have your *Windows* distribution CD handy!):

- Go to the *Control Panel* (*Start* → *Settings* → *Control Panel*) and double-click on the

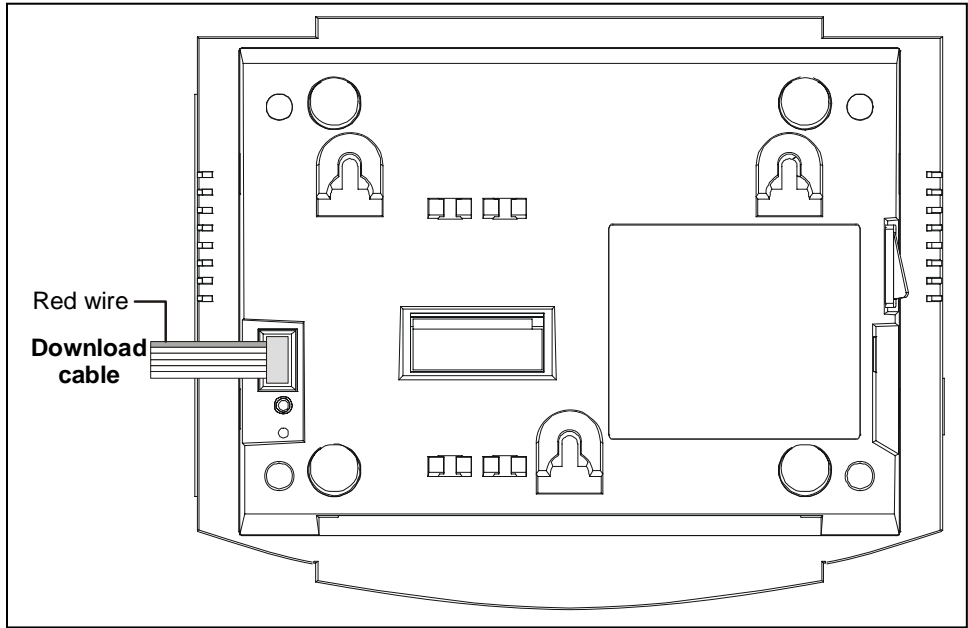

Add/Remove Programs icon- the *Add/Remove Programs* dialog will open

- Click on *Windows Setup* tab to view the list of optional installation components
- Choose *Communications* in the *Components* list and click *Details*
- In the *Communications* window, select the *HyperTerminal* (it must be “checked”)
- Press *OK* to close *Communications* window, press *OK* again to close *Add/Remove Programs*
- It is probable that you will be asked to insert the *Windows* CD at this point. Do this and follow the instructions on the screen.

Once the *HyperTerminal* is installed, follows the procedures below to download new firmware file into the TR4050:

- Switch the TR4050 off
- Plug the Download Cable into the TR4050 as shown on the figure (with the cable going outwards!)

Application Download Port and the PC/Master Port of the TR4050 share the same hardware internally. When downloading the firmware, make sure that no cable is attached to the PC/Master Port.

- Plug the Download Cable into the male side of the Serial Cable. Plug the other side of the Serial cable into your PC’s COM port
- Launch the *Hyper Terminal* and configure it as follows:
 - When the *Connection Description* dialog opens, type any string (1 character minimum) and press *OK*
 - When the *Connect to* dialog opens, select an appropriate COM port from the *Connect Using* drop-down box (for example, “Direct to COM1”)

- When the *COM Properties* dialog appears, set communications parameters as follows:
Bits per second: 38400, Data bits: 8, Parity: None, Stop bits: 1, Flow control: None.
 Click *OK* when done- the *HyperTerminal's* main window will appear
- Choose *Transfer* → *Send file* from the *Main* menu- the *Send file* dialog will appear
- In the *Send file* dialog, select the firmware file that you want to download into the TR4050 (see [Obtaining the most recent firmware version](#) for details on how to get this file) and choose the *Xmodem protocol* from the *Protocol* drop-down box. Click *OK* when finished
- The *Xmodem file send for a* dialog will be displayed
- Switch the TR4050 on. The Terminal's screen will display:

MONITOR (v3.0G)
 Loading...

- Simultaneously, the file transfer will begin. When the transfer is finished, the TR4050s LCD will show "OK".
- Switch the TR4050 off and disconnect the Download Cable from the Application Download Port (ADP)
- Switch the TR4050 back on again- the Terminal should display the MONITOR screen for couple of seconds, then launch the newly loaded application firmware. Normally, the first step will be a System Reset. When it is finished, you will be requested to switch the Terminal off and on again. See [Powering up for the first time](#) for complete details on what to do next.

Possible download problems

A number of errors can occur during when downloading new firmware:

COMM(unications) error

This means that something went wrong during firmware file downloading. One common reason for this is incorrect communications parameters setting in the HyperTerminal. Check the HyperTerminal setting carefully and try again.

ExtFLASH failure or IntFLASH failure

This indicates a serious hardware malfunction. Please, return your TR4050 for service/repair.

File is too big or Invalid boot code

This means that you are trying to download an invalid file.

CHECKSUM error. No code loaded or code is damaged

This means that currently loaded firmware is invalid. Most probably, the last firmware download process was not completed (i.e. the code was not fully loaded). Try downloading the firmware file again. If the problem persists then something must be wrong with the firmware file itself. Check if you are downloading a correct firmware file. Contact us if you cannot solve the problem.

D.6. Time and Attendance data file format

The TR4050 saves the time/attendance data onto a USB Disk using a so-called delimited text format. This data format is widely accepted by a variety of different software packages including the *Microsoft Excel*, *Access* and many others.

With delimited text format, fields within a record are separated by a TAB character (tabulation, ASCII= 09 Hex) while records are separated from each other by CR (Carriage Return, ASCII= 0D Hex) and LF (Line Feed, ASCII= 0A Hex) characters. Fields are guaranteed to contain ASCII characters in the 20-7F Hex only. All numerical values are represented by their string equivalents.

Each TR4050's record consists of the following fields:

Field	Length*	Format
Event	1	<i>E</i> , can be "1", "2", "3" or "4"
Date	10	"DD-MM-YYYY"
Time	8	"hh:mm:ss"
ID-code	Variable	"xx...x", apostrophe is added to make sure that this field is treated as a string by applications like <i>Microsoft Excel</i>
Shift	2	"SS", can be in the range from 00 to 99
Machine No	2	"NN", can be in the range from 00 to 99

*Length doesn't include the TAB character

The ID-code field content can be fine customized. See [Fine-tuning ID-code processing](#) for more information.

D.7. Bell and Lock control relays

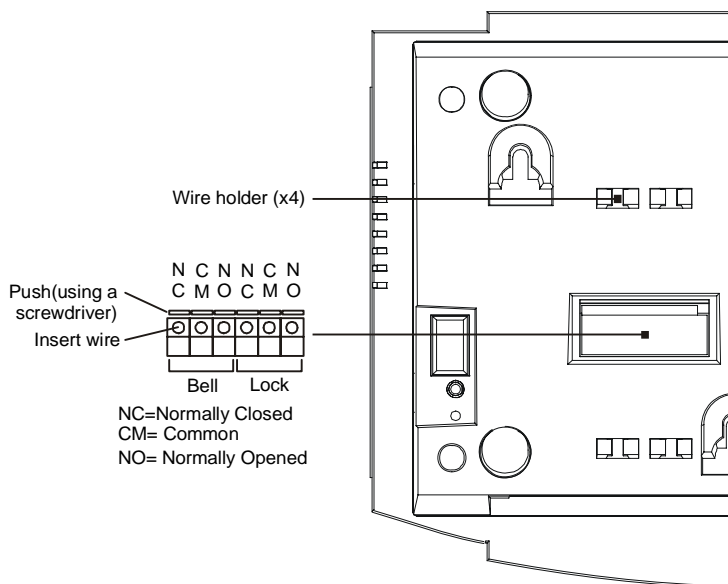

The TR4050 features two identical internal Relays with 2A switching capability (average current, peak current can be up to 10A). Relay #1 is used to control an external Bell (Ring), relay #2 controls an Electric Lock. Both normally-closed and normally-opened contacts are provided.

Relay #1 activates the bell at pre-programmed daytimes, in accordance with the [Bell Table](#). The bell is activated for a period of time specified by the [Bell duration](#) Setting. See [Controlling external Bell \(Ring\)](#) for more information.

Relay 2 activates the Lock each time a valid User ID-card or Fingerprint is read. The Lock is activated for a period of time specified by the [Lock activation duration](#) Setting. See [Using the TR4050 as an Access Control Terminal](#) for more information.

Both external Bell and Lock are wired to the TR4050's terminal block connector located on the TR4050's base cover. There are 3 contacts provided for each relay: common, normally-closed and normally-opened. To plug a wire into the connector, push the orange lever down using a flat screwdriver (or some

other handy object), insert the wire and release the lever. There are several wire holders that you can use to arrange the wires.

D.8. I/O Connector pin assignment & Cable wiring

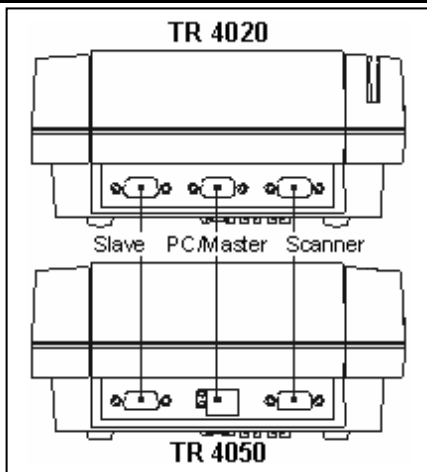

D.8.1. TR4020/4050 I/O connector pin assignment

The TR4020 features three serial ports: PC/Master, Slave, and Scanner port. The TR4050 has two serial ports (Slave and Scanner) and one Ethernet port (see the Drawing to the left).

Note: Application Download Port (see [Downloading new application firmware](#)) shares some internal hardware with the PC/Master port on the TR4020 and the Ethernet circuitry of the TR4050. The PC/Master port of the TR4020 and the Ethernet port of the TR4050 will NOT work properly when the Download cable is attached!

To avoid common confusion, all pins are designated as inputs and outputs with respect to the Terminal.

Slave (TR4020/4050)		PC/Master (TR4020)		PC/Master (TR4050)		Scanner (TR4020/4050)	
#1	No connection	#1	No connection	#1	TX+	#1	No connection
#2	RX (Input)	#2	TX (Output)	#2	TX-	#2	RX (Input)
#3	TX (Output)	#3	RX (Input)	#3	RX+	#3	TX (Output)
#4	No connection	#4	DSR (Input)	#4	No connection	#4	No connection
#5	Ground	#5	Ground	#5	No connection	#5	Ground
#6	No connection	#6	DTR (Output)	#6	RX-	#6	No connection
#7	RTS (Output)	#7	CTS (Input)	#7	No connection	#7	No connection
#8	CTS (Input)	#8	RTS (Output)	#8	No connection	#8	No connection
#9	No connection	#9	No connection			#9	+5V (100mA)

D.8.2. RS232 cable wiring

WAS-1404	
DB9M (Male side)	DB9F (Female side)
#2 ←	→ #2
#3 ←	→ #3
#5 ←	→ #5
#7 ←	→ #7
#8 ←	→ #8

TR4020/4050 use the Male-Female, DB9 connector type, “direct” wiring type. This cable can be used both for PC to Terminal connection and for connection between the Terminals (see [Online communications with the TR4020](#)). Our part number for this cable is **WAS-1404**.

D.8.3. Ethernet cable wiring

Ethernet port of the TR4050 is a standard Unshielded Twisted Pair (UTP) port. Normally, you would like to connect the TR4050 to the Local Area Network (see [Online communications with the TR4020](#)). This is done via Ethernet hub. Use the “direct” wiring scheme in this case. “Direct” wiring will not work if you want to connect the TR4050 to the PC bypassing the Ethernet hub. Use “Cross” wiring scheme instead. Always use a standard UTP (Category III or IV) cable for wiring. Our part number for direct (hub-to-Terminal) cable is **WAS-1499**; for cross (PC-to-Terminal)- **WAS-1498**.

Direct wiring (WAS-1499)	
Side A	Side B
#1 ← (*)	→ #1
#2 ← (*)	→ #2
#3 ← (**)	→ #3
#4 ←	→ #4
#5 ←	→ #5
#6 ← (**)	→ #6
#7 ←	→ #7
#8 ←	→ #8

(*) #1, #2 must share the same twisted pair;

(**) #3, #6 must share the same twisted pair;

Cross wiring (WAS-1498)	
Side A	Side B
#1 ← (*)	→ #3
#2 ← (*)	→ #6
#3 ← (**)	→ #1
#4 ←	→ #4
#5 ←	→ #5
#6 ← (**)	→ #2
#7 ←	→ #7
#8 ←	→ #8

D.9. Rotating base cover for desktop operation

The TR4050 can be used as a wall-mount (default) or a desktop device. For convenient desktop operation, a *base cover* must be rotated to adjust the front panel viewing angle. To rotate the base cover:

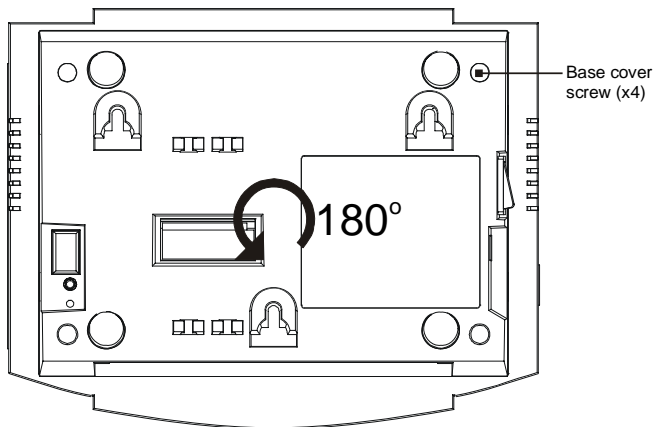

- Switch the TR4050 off and unplug the power cord
- Remove four base cover screws
- Lift the base cover. Note that there is a flat cable running between the base cover and the rest of the unit. Plus, there are 2 wires (black and red) running from the battery. Make sure that both the flat cable and the wires don't get unplugged while you are rotating the cover
- Rotate the cover 180 degrees counter-clockwise and press gently back into its position (clearly visible as a slight recess in plastic). Make sure that the flat cable is neatly folded inside
- Insert and tighten the base cover screws

D.10. Specifications & Ordering Information

LCD	104 x 52, black & white, no backlight
Fingerprint Reader (TR4050)	Fingerprint capacity: 1900 Fingerprint Validation: 1:n Identification speed: <1 sec(1:1), <2 sec(1:n)
RFID reading distance (Mifare Card)	2 cm.
Database capacity	App. 12000 records (depends on the firmware version)
Interface (TR4020):	3x RS232 ports (PC/Master, Slave, Scanner)
Interface (TR4050):	1x Ethernet port (PC/Master), 2x RS232 ports (Slave, Scanner)
USB Disk Port	Supports USB Mass Storage Device only (not with Embedded Hub), FAT12, FAT16, FAT32 file system
Bell and Lock relays	Max 24V, 2A continuous (10A peak)
Mounting	Wall-mount or desktop (rotating back cover)
Power supply:	DC 12V, 500mA
UPS battery capacity	2 hours (completely recharges in 72 hours)
Operation Temperature	0-50 °C
Operating relative humidity	10-90%
Unit dimensions	187mm(L) x 147mm(W) x 95mm(H)
Packaging dimensions	260mm(L) x 235mm(W) x 120mm(H)
Net weight	1.1Kg